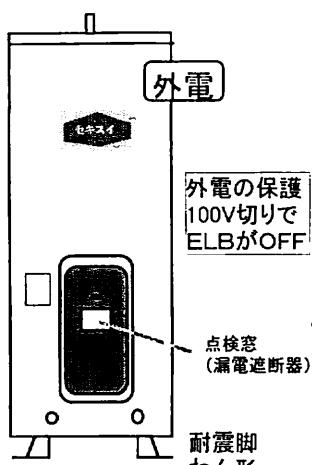
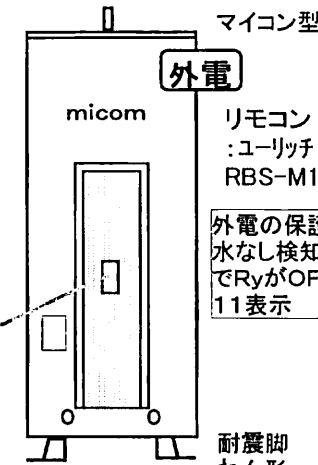
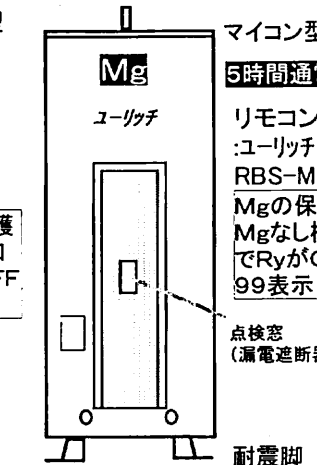
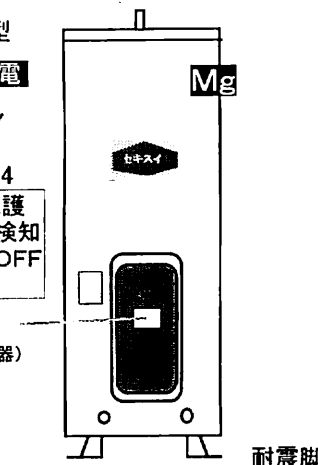
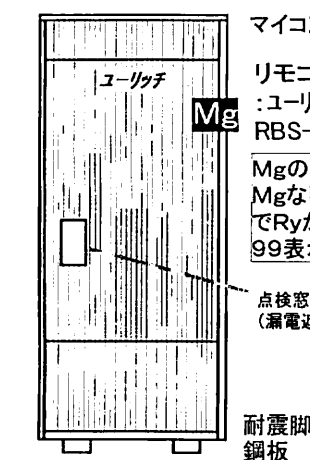
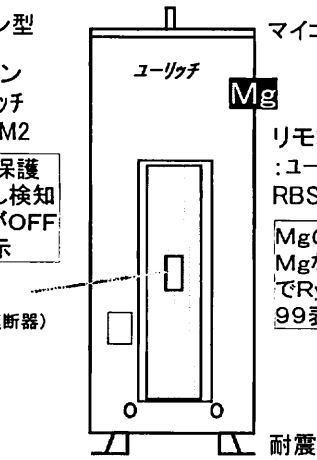
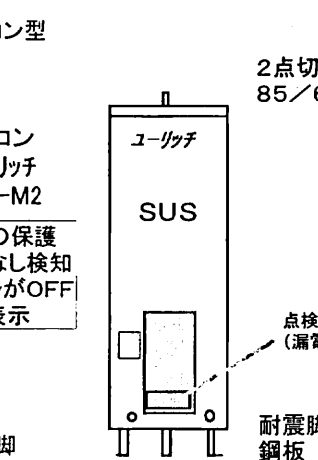
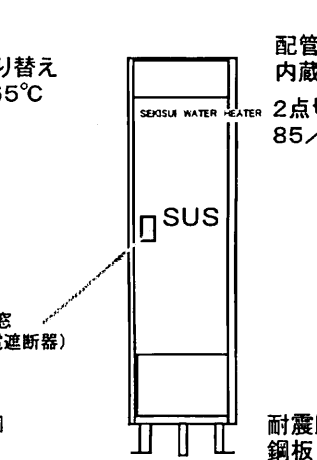

1986~1987 1986~1987 1986~1987 1987~1988

 <p>外電</p> <p>外電の保護 100V切りで ELBがOFF</p> <p>点検窓 (漏電遮断器)</p> <p>耐震脚 わん形</p> <p>MS-30E34 MS-37E34 MS-46E34</p>	 <p>マイコン型</p> <p>外電</p> <p>micom</p> <p>リモコン :ユーリッチ RBS-M1</p> <p>外電の保護 水なし検知 でRyがOFF 11表示</p> <p>耐震脚 わん形</p> <p>MS-37M24 MS-46M24</p>	 <p>マイコン型</p> <p>Mg</p> <p>ユーリッチ</p> <p>5時間通電</p> <p>リモコン :ユーリッチ RBS-M4</p> <p>Mgの保護 Mgなし検知 でRyがOFF 99表示</p> <p>点検窓 (漏電遮断器)</p> <p>耐震脚 わん形</p> <p>MS-37M42 MS-46M42</p>	 <p>Mg</p> <p>SEKISUI</p> <p>MS-30E45 MS-37E45 MS-46E45</p>
--	---	---	--

1987~1988 1987~1988 1987~1989 1988~1989

 <p>マイコン型</p> <p>ユーリッチ</p> <p>Mg</p> <p>リモコン :ユーリッチ RBS-M2</p> <p>Mgの保護 Mgなし検知 でRyがOFF 99表示</p> <p>点検窓 (漏電遮断器)</p> <p>耐震脚 鋼板</p> <p>RC-37M15 MS-37M15 RC-46M15 MS-46M15 RC-30MT2</p>	 <p>マイコン型</p> <p>ユーリッチ</p> <p>Mg</p> <p>リモコン :ユーリッチ RBS-M2</p> <p>Mgの保護 Mgなし検知 でRyがOFF 99表示</p> <p>耐震脚 わん形</p> <p>MS-37M25 MS-46M25</p>	 <p>ユーリッチ</p> <p>SUS</p> <p>2点切り替え 85/65°C</p> <p>点検窓 (漏電遮断器)</p> <p>耐震脚 鋼板</p> <p>MS-15N81 MS-15N51 MS-20N81 MS-20N51</p>	 <p>SEKISUI WATER HEATER</p> <p>SUS</p> <p>配管 内蔵 2点切り替え 85/65°C</p> <p>耐震脚 鋼板</p> <p>RS-15N81 RS-15N51 RS-20N81 RS-20N51</p>
--	---	---	--

1988~1989 1988~1989 1988~1989

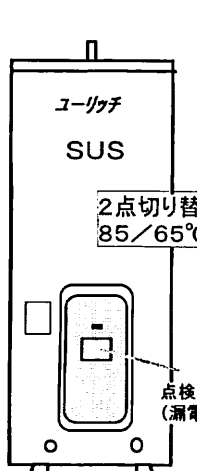
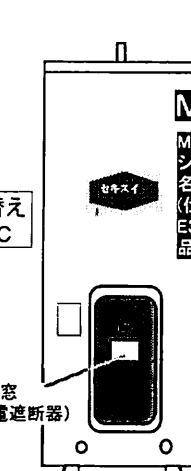
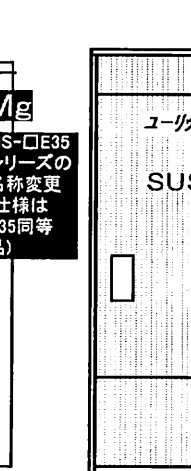
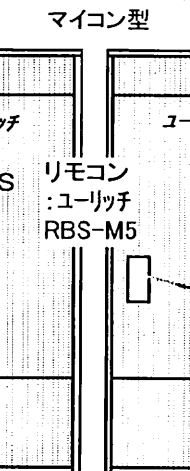
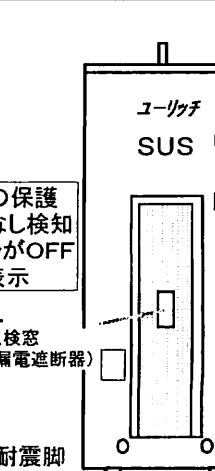
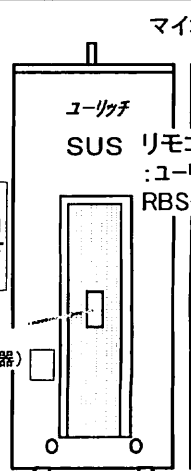
 <p>ユーリッチ</p> <p>SUS</p> <p>2点切り替え 85/65°C</p> <p>点検窓 (漏電遮断器)</p> <p>耐震脚 わん形</p> <p>MS-30N81 MS-37N81 MS-46N81</p>	 <p>SEKISUI</p> <p>Mg</p> <p>MS-□E35 シリーズの 名称変更 (仕様は E35同等 品)</p> <p>点検窓 (漏電遮断器)</p> <p>耐震脚 わん形</p> <p>MH-30E81 MH-37E81 MH-46E81 MH-30E51</p>	 <p>マイコン型</p> <p>ユーリッチ</p> <p>SUS</p> <p>リモコン :ユーリッチ RBS-M5</p> <p>点検窓 (漏電遮断器)</p> <p>耐震脚 鋼板</p> <p>KS-37M81 KS-37M82 KS-46M81 KS-46M82 RS-37M81 RS-46M81</p>	 <p>マイコン型</p> <p>ユーリッチ</p> <p>Mg</p> <p>Mgの保護 Mgなし検知 でRyがOFF 99表示</p> <p>点検窓 (漏電遮断器)</p> <p>耐震脚 鋼板</p> <p>KH-37M81 KH-37M82 KH-37M51 KH-46M81 KH-46M51</p>	 <p>ユーリッチ</p> <p>SUS</p> <p>リモコン :ユーリッチ RBS-M5</p> <p>点検窓 (漏電遮断器)</p> <p>耐震脚 わん形</p> <p>MS-37M81 MS-37M82 MS-46M81 MS-46M82</p>	 <p>ユーリッチ</p> <p>Mg</p> <p>Mgの保護 Mgなし検知 でRyがOFF 99表示</p> <p>耐震脚 わん形</p> <p>MH-37M81 MH-37M82 MH-46M81 MH-46M82</p>
---	---	--	---	---	---

□M(E)81シリーズ以前(初期のMSBシリーズを除く)の温度過昇防止器(105°C設定)はELBでOFFする

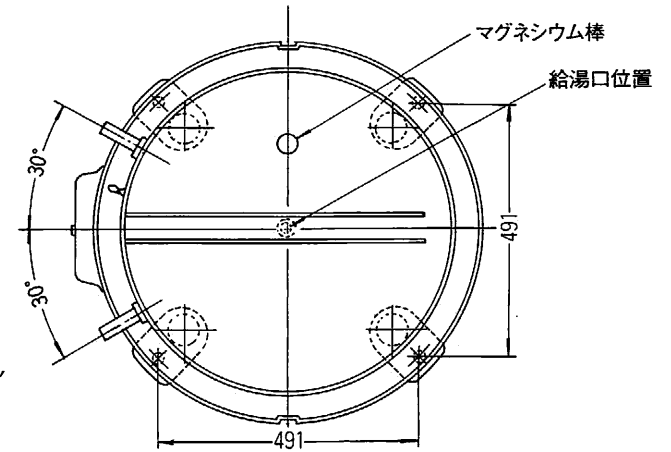
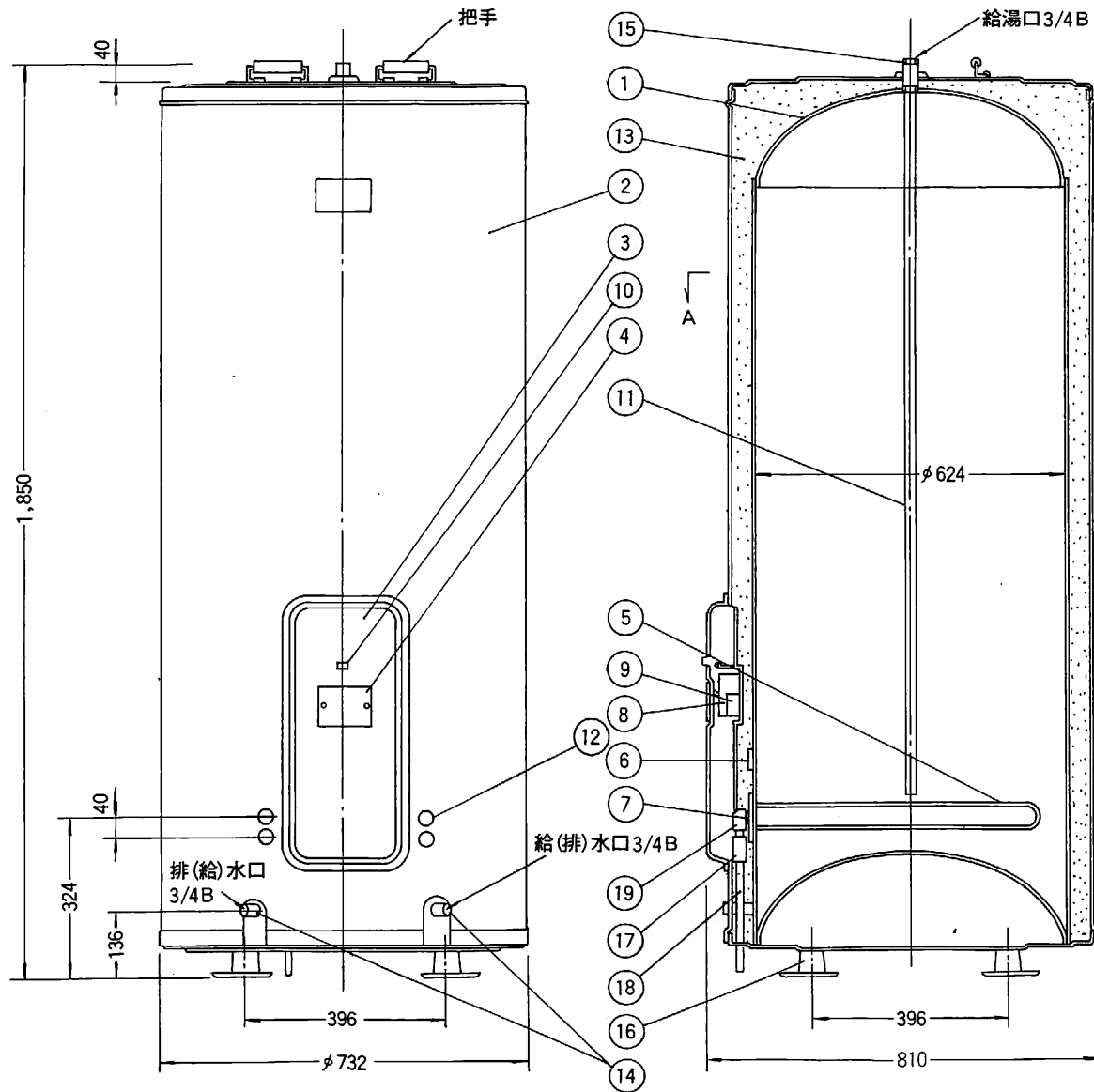

A-A' 断面図

19	ストリートエルボ	青銅鋳物	1	JIS H-5111	BC-6	3/4"	
18	ホース	ゴム	1			EPT	
17	逃し弁	快削黄銅棒	1	JIS H-3422	BSBM2	3/4"	
16	脚	銅板	4			Znメッキ	
15	給湯口	配管用ステンレス鋼管	1	JIS G-3459	SUS-304	3/8"	
14	給排水口	配管用ステンレス鋼管	2	JIS G-3459	SUS-304	3/8"	
13	保温材	グラスウール	1			16kg/m ³	
12	電源線取入口	ゴム	4				
11	マグネシウム棒		1			AZ-31	
10	通電表示ランプ		1			ネオン式	
9	電源端子台		1			3P 250V 35A	
8	接地しゃ断器		1			30mA/0.1sec	
7	温度過昇防止器	バイメタル式	1			105°C ±5°C	
6	温度調節器	バイメタル式	2			85°C ±5°C	
5	発熱体	リン脱酸銅	1	JIS H-3603	Dcu T-1	200V 5.4kw ニッケルメッキ	
4	点検窓	プラスチック	1				
3	前カバー	亜鉛メッキ鋼板	1				アクリル換付
2	外装	亜鉛メッキ鋼板	1				アクリル換付
1	タンク	熱間圧延軟鋼板	1	JIS G-3131	SPHC		
品番	品名	材	料	個数	規格	記号	備考

承認図	名称	セキスイ自動電気温水器 MH-4GE8I				
	三角法	尺度	単位	mm	図番	NHTCD-87016
積水化学工業株式会社						

〔注意事項〕 水源に市水道を使用する場合は、市町村条例に基づいた施行を行うこと